



qubino®

Your little magic for the smartest home.

USER MANUAL **EN**

QUBINO SMART PLUG 16A



The Qubino Smart Plug 16A is ideal for remotely controlling electrical devices and measuring the energy consumption.

Table of contents

About Qubino	3
Safety Information	5
Smart Plug 16A - Available Frequencies.....	6
Where To Buy	6
1. Introduction	7
2. Use Cases	9
2.1. Usage examples for Smart Plug 16A – for switching device on/off and measuring power consumption of the connected device	9
2.2. Usage examples for Smart Plug 16A – for measuring power consumption of the connected device	11
2.3. Additional features of Smart Plug 16A which can make your life easier	12
3. Qubino Smart Plug 16A Advantages and Highlights	14
3.1. Advantages	14
3.2. Highlights	16
4. Package Contents.....	17
5. Compatibility with Z-Wave Gateways (hubs).....	18
6. Installation	19
6.1. Installing the device.....	20
7. Device Information and Support.....	23
8. Electrical Diagram 230VAC.....	24
9. Adding the device to a Z-Wave network (Inclusion)	26
10. Removing the device from a Z-Wave network (Exclusion).....	27
11. Associations	28
12. Configuration Parameters.....	29
13. Technical Specifications	38
14. Z-Wave Command Classes	39
15. Important Disclaimer	40
16. Warning	40
17. Regulations	40

About Qubino

Qubino is a family of innovative Z-Wave devices, many of them the smallest of their kind. Numerous breakthrough innovations, 100% quality control, and responsive customer service make Qubino the number one choice for making your life more comfortable.

Qubino enables you to transform – inexpensively and invisibly – any traditional electric device into a smart, connected one that you can control with your smart phone. Qubino devices are simple to install and use, but also extremely versatile - they offer a wealth of additional features and parameters for you to play with.

We love helping people who enjoy creating new ideas for their home and then using their hard work and skill to turn those ideas into reality. We admire their passion and resourcefulness. We do our best to supply you with products that will enable you to create a unique and special home for yourself. We innovate so that you can be free to make the smartest home possible. With just a touch of magic.

"Simple is smart." We believe it is smart to make complex things simple. But only when this means simple for our customers, not for ourselves. We think a lot so that you won't have to when it comes to installing or using our devices.

For more information visit: www.qubino.com



About Z-Wave:

The Z-Wave protocol is an interoperable, wireless, RF-based communications technology designed specifically for control, monitoring, and status reading applications in residential and light commercial environments. Mature, proven, and broadly deployed (with over 50 million products sold worldwide), Z-Wave is by far the world market leader in wireless control, bringing affordable, reliable, and easy-to-use 'smart' products to millions of people in every aspect of daily life.

Source: www.z-wavealliance.org

Safety Information

For Qubino, safety is first, so we have prepared lots of safety tips and information that can be found throughout this manual.

To ensure your safety, please read this manual carefully before installing the device; follow the instructions exactly. The manufacturer (GOAP d.o.o. Nova Gorica) shall not be legally responsible for any equipment damage or personal injury caused by incorrect installation or operation other than that covered in this manual.

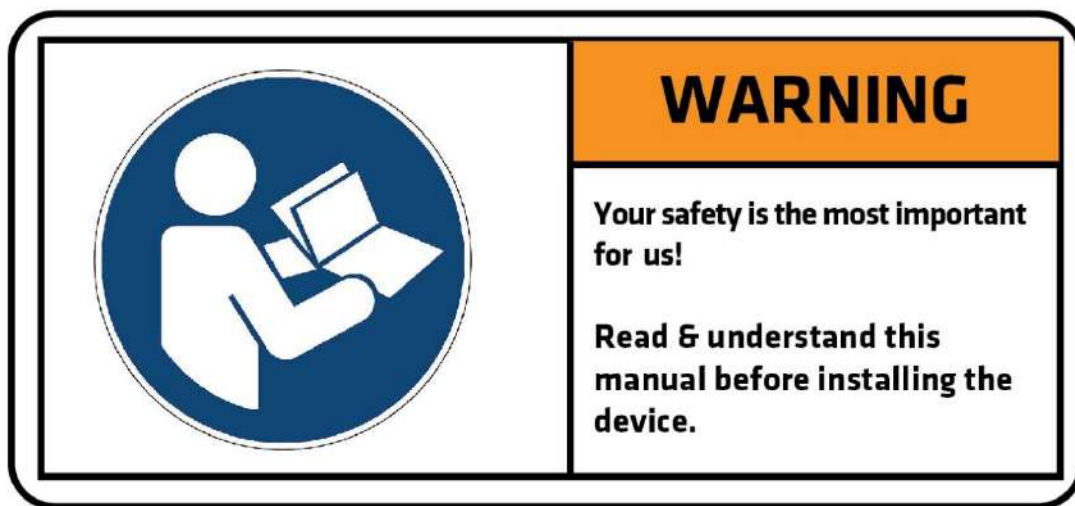

i Please check the Technical Specifications and Electrical Diagram chapters, as well as fuse requirements in the Installation chapter before installing the device.

Smart Plug 16A - Available Frequencies

 **Note:** the Smart Plug 16A is compatible only with socket type F.

ORDERING CODE (MODEL NUMBER)	POWER SUPPLY FREQUENCY	Z-WAVE FREQUENCY*
ZMNHYD1	50/60 Hz	868,4 MHz
ZMNHYD4	50/60 Hz	869,0 MHz
ZMNHYD6	50/60 Hz	868,4 MHz
ZMNHYDA	50/60 Hz	919,7 – 921,7 – 923,7 MHz
ZMNHYDB	50/60 Hz	868,1 MHz
ZMNHYDE	50/60 Hz	920,9 MHz

*You can check the Z-Wave frequency in your country here:

https://z-wave.sigmadesigns.com/wp-content/uploads/Z-Wave_Frequency_Coverage-.pdf

Where To Buy

To find your nearest Qubino dealer visit: <http://qubino.com/where-to-buy/>

1. Introduction

The Smart Plug 16A controls on/off function for the connected device. It also measures power consumption of the connected device according to the principle of fast sampling of voltage and current signals. A built-in microprocessor calculates energy and power from the measured signals.

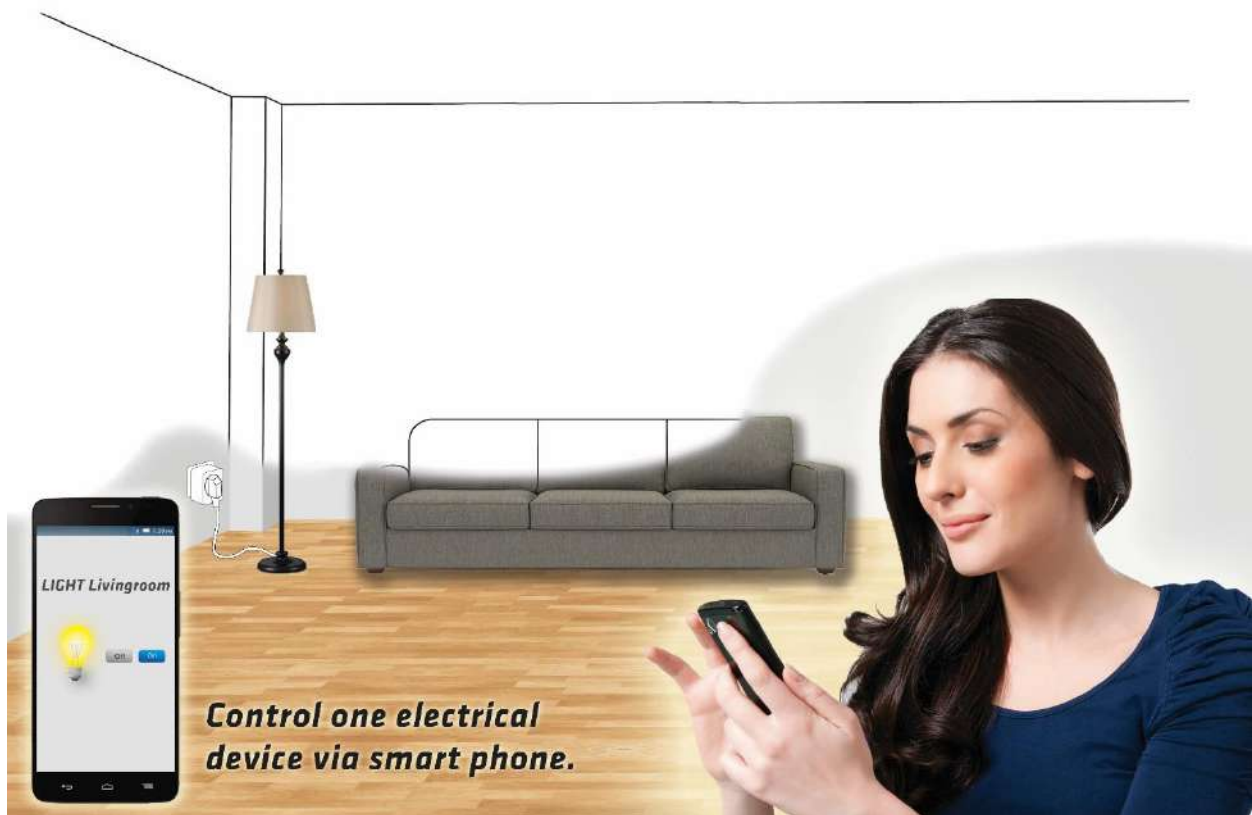

The Qubino Smart Plug 16A also acts as a Z-Wave repeater to improve the range and stability of the Z-Wave network.

Smart Plug 16A supported functions:

Turn ON/OFF	W Measurement	kWh Measurement	Current (A) Measurement	Voltage (V) Measurement	Automatically turn ON/OFF	Associations	Z-Wave Repeater	Auto-inclusion
✓	✓	✓	✓	✓	✓	✓	✓	✓











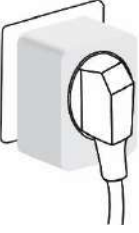

Control your house from anywhere

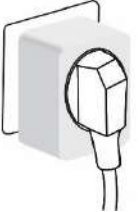
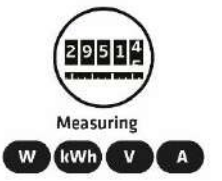

2. Use Cases

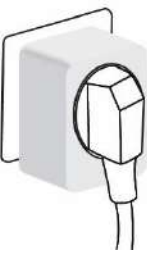
The Smart Plug 16A can be used in many different scenes, which can help make your life more comfortable. We have prepared a few of them for you—so you can get an idea for your next smart home project. Of course, there are countless of other options for how to use the Qubino Smart Plug 16A to remotely control devices via your smartphone.

2.1. Usage examples for Smart Plug 16A – for switching device on/off and measuring power consumption of the connected device

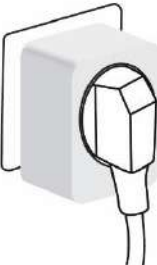
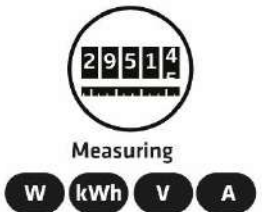
<ul style="list-style-type: none">Remotely control a lamp    	<ul style="list-style-type: none">Remotely control domestic hot water tank    
<ul style="list-style-type: none">Remotely control an oven    	<ul style="list-style-type: none">Remotely control an iron    

- Remotely control a fan

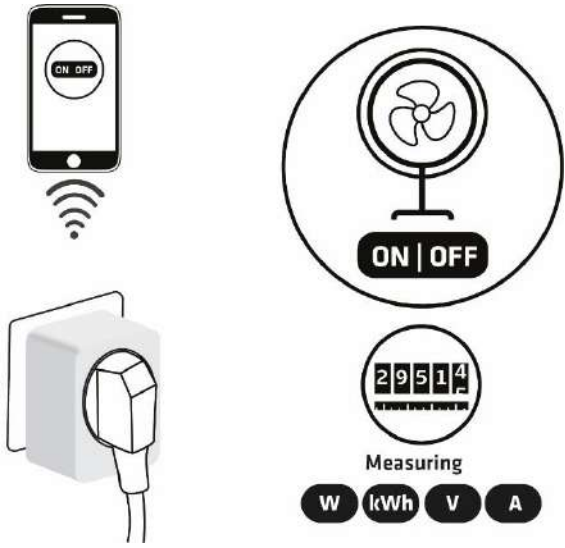

- Remotely control an electric radiator

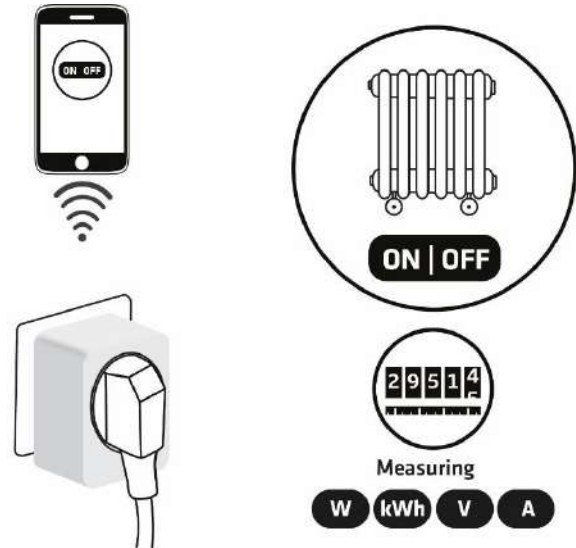

2.2. Usage examples for Smart Plug 16A – for measuring power consumption of the connected device

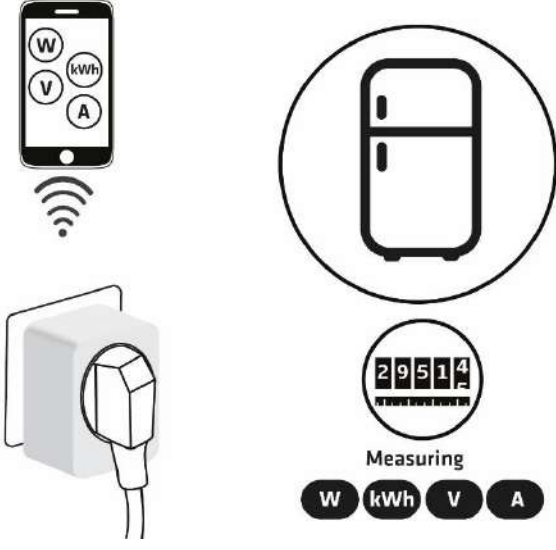
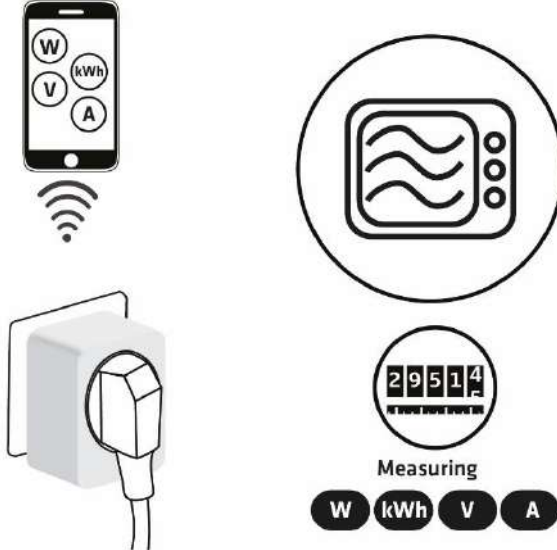
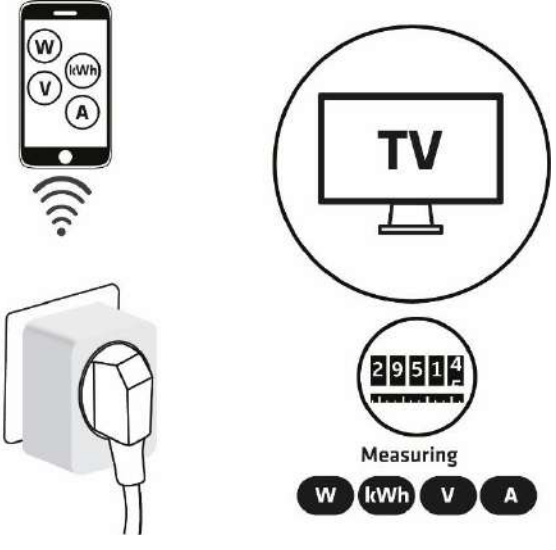
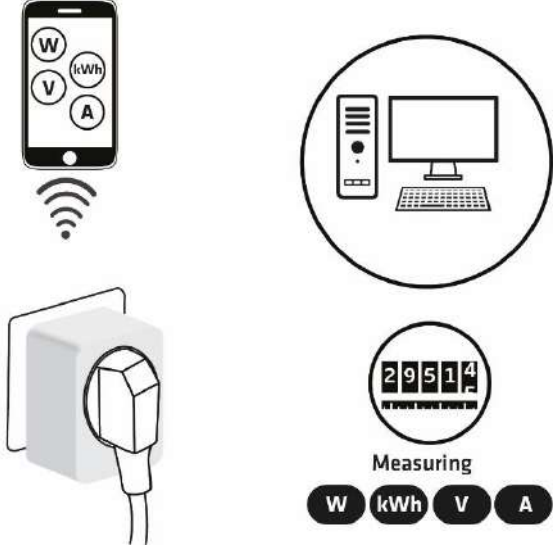
<ul style="list-style-type: none">• Remotely measure power consumption of refrigerator  <p>The diagram shows a smart plug connected to a refrigerator. A smartphone is shown with a Wi-Fi signal icon and a screen displaying power measurement units: W, kWh, V, and A. Below the plug, a circular display shows the number 29514, with the word 'Measuring' underneath. At the bottom, four buttons are labeled W, kWh, V, and A.</p>	<ul style="list-style-type: none">• Remotely measure power consumption of microwave oven  <p>The diagram shows a smart plug connected to a microwave oven. A smartphone is shown with a Wi-Fi signal icon and a screen displaying power measurement units: W, kWh, V, and A. Below the plug, a circular display shows the number 29514, with the word 'Measuring' underneath. At the bottom, four buttons are labeled W, kWh, V, and A.</p>
<ul style="list-style-type: none">• Remotely measure power consumption of television  <p>The diagram shows a smart plug connected to a television. A smartphone is shown with a Wi-Fi signal icon and a screen displaying power measurement units: W, kWh, V, and A. Below the plug, a circular display shows the number 29514, with the word 'Measuring' underneath. At the bottom, four buttons are labeled W, kWh, V, and A.</p>	<ul style="list-style-type: none">• Remotely measure power consumption of computer connected to a power socket  <p>The diagram shows a smart plug connected to a computer system (tower PC, monitor, and keyboard). A smartphone is shown with a Wi-Fi signal icon and a screen displaying power measurement units: W, kWh, V, and A. Below the plug, a circular display shows the number 29514, with the word 'Measuring' underneath. At the bottom, four buttons are labeled W, kWh, V, and A.</p>

2.3. Additional features of Smart Plug 16A which can make your life easier

- **Do you often forget to turn off devices when you leave your home, like lights in the basement or attic?**
- The Smart Plug 16A can automatically turn devices/lights on or off after a set period of time (when you're away from home). For example, the light will automatically turn off if it's been on for 8 hours, let's say. This function is independent of other scenes and gateway (hub) commands.

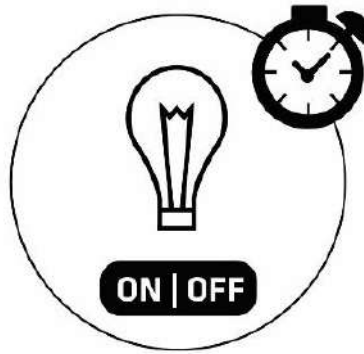

- Do you know how much energy you consume?
- The Smart Plug 16A monitors and reports energy consumption of connected devices in real time to your smart home app (your gateway (hub) needs to support this feature). Know how much power your light, domestic water tank, iron, etc, is using.

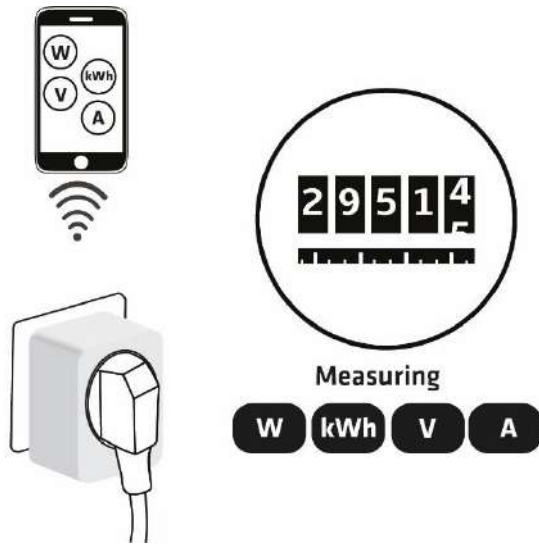

- Want to control other devices in your Z-Wave network with the Smart Plug 16A?
- Connect the Smart Plug 16A with other devices in your network to remotely and automatically trigger another Z-Wave device. And have other Z-Wave devices trigger your Qubino Smart Plug 16A.

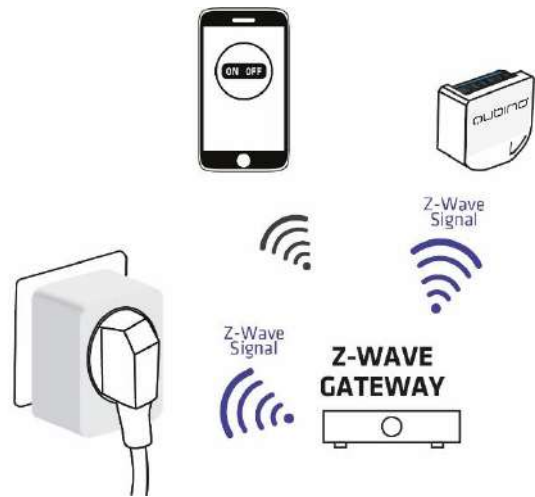

3. Qubino Smart Plug 16A Advantages and Highlights

3.1. Advantages

- The Qubino Smart Plug 16A allows the **easiest and quickest installation possible**: It is plug&play device which means that no installation skills are needed for the device set up. The device fits into any schuko power socket.

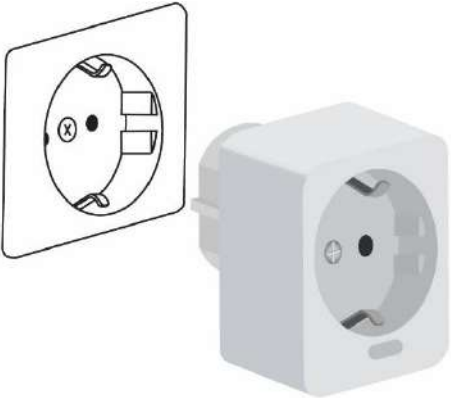

- The Qubino Smart Plug 16A allows the possibility to manage all appliances in your apartment. You will not be limited to use it only on the small energy consumers. This is possible because Qubino Smart Plug 16A is the only smart plug in the world that supports 16A current.

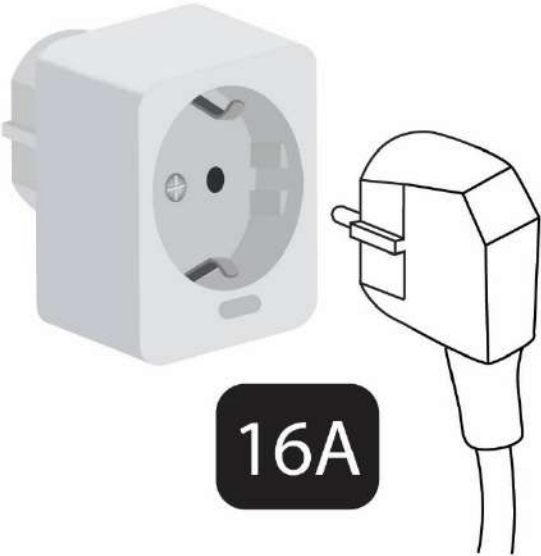

- Qubino guarantees **100% device quality**. Such high quality can be delivered because every Qubino goes through rigorous quality control standards throughout the production process. Every device has a unique serial number and a part number, which are assigned to the device only after it goes through a strict testing procedure.

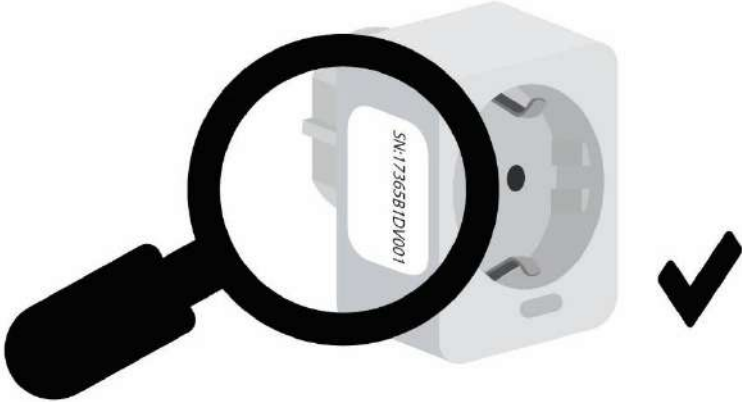

- By scanning the QR code on the back of your Qubino device, the serial and part numbers will be automatically copied on your mobile phone; they also provide **direct access to Qubino’s technical support team**. The serial and part numbers of your device are given automatically every time you open an inquiry with our support team: this instantly shares the relevant device information we need to provide the best technical support possible. For details, please see the Device Information and Support chapter.



- The Qubino Smart Plug 16A is certified by an independent Institute and has LVD and EMC certificates to ensure the highest safety standards.

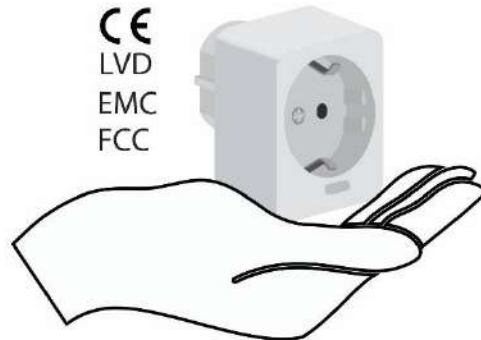

3.2. Highlights

- Remote (via smartphone or PC) and local on/off control of bulbs and electrical appliances such as irons, microwave, fans etc.
- Capable of measuring the power consumption of the connected device in real time via smartphone, which allows you to save on electricity bills*
- Features one of the easiest and quickest installations of devices
- Saves and restores the last status after a power failure
- Supports auto-inclusion mode for quick set up
- **Can be set up anywhere in the house and moved freely, so you can put it in any room you like**
- Can automatically turn devices on and off after a set period of time (helpful when you're away from home, for example) *
- Supports additional parameters for expert users, which allows for advanced configuration*
- Acts as a signal repeater which improves the range and stability of your Z-Wave network
- Can be used to remotely control and trigger other devices in your Z-Wave network

*Your gateway (hub) needs to support advanced configuration and parameter input if you wish to use this feature

4. Package Contents

- Smart Plug 16A Device
- Installation Manual

5. Compatibility with Z-Wave Gateways (hubs)

Please check compatibility with your Z-Wave gateway (hub) before you purchase this device. The compatibility table is in preparation, for any information, please contact us at: <http://qubino.com/support/#email>.

6. Installation

Before installing the device, please read the following carefully and follow the instructions exactly:

 **Note!**

Do not connect the device to loads exceeding the recommended values. Connect the device exactly as shown in the provided diagrams. Improper use may be dangerous and result in equipment damage.

Electrical installation must be protected by directly associated overcurrent protection fuse with rated current up to 16A.

6.1. Installing the device

The installation consists of the following simple steps:

Step 1 – Enable inclusion mode on your gateway (hub)



Step 2 – Insert the Smart Plug 16A device into the socket – the device will be automatically added in your z-wave network

STEP 2

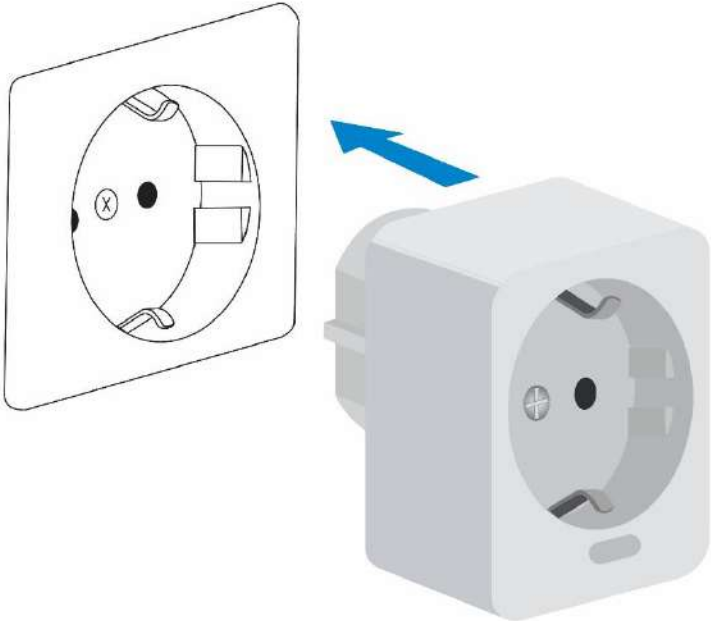

Step 3 – Connect the desired load (electrical device) with the Smart Plug 16A

STEP 3

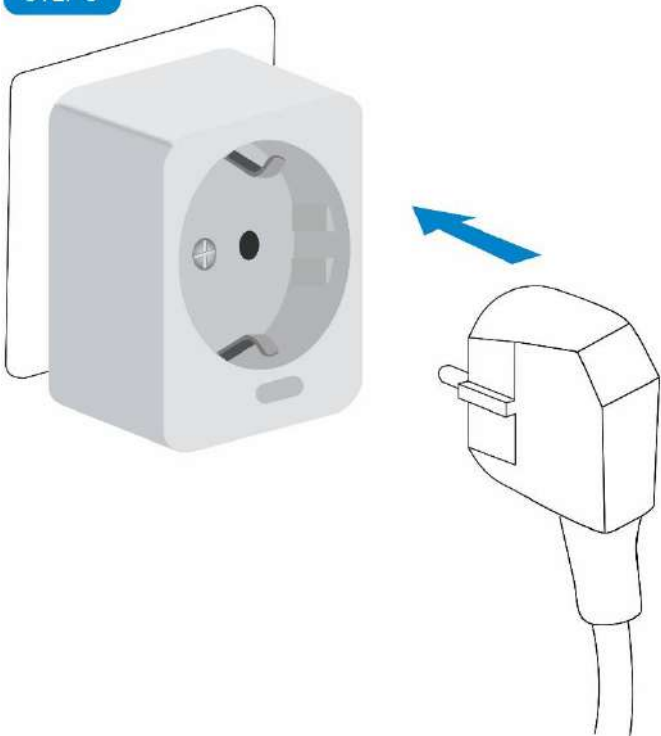

Step 4 – The Installation is now complete. It’s time to make your life more comfortable with the help of the Qubino Smart Plug

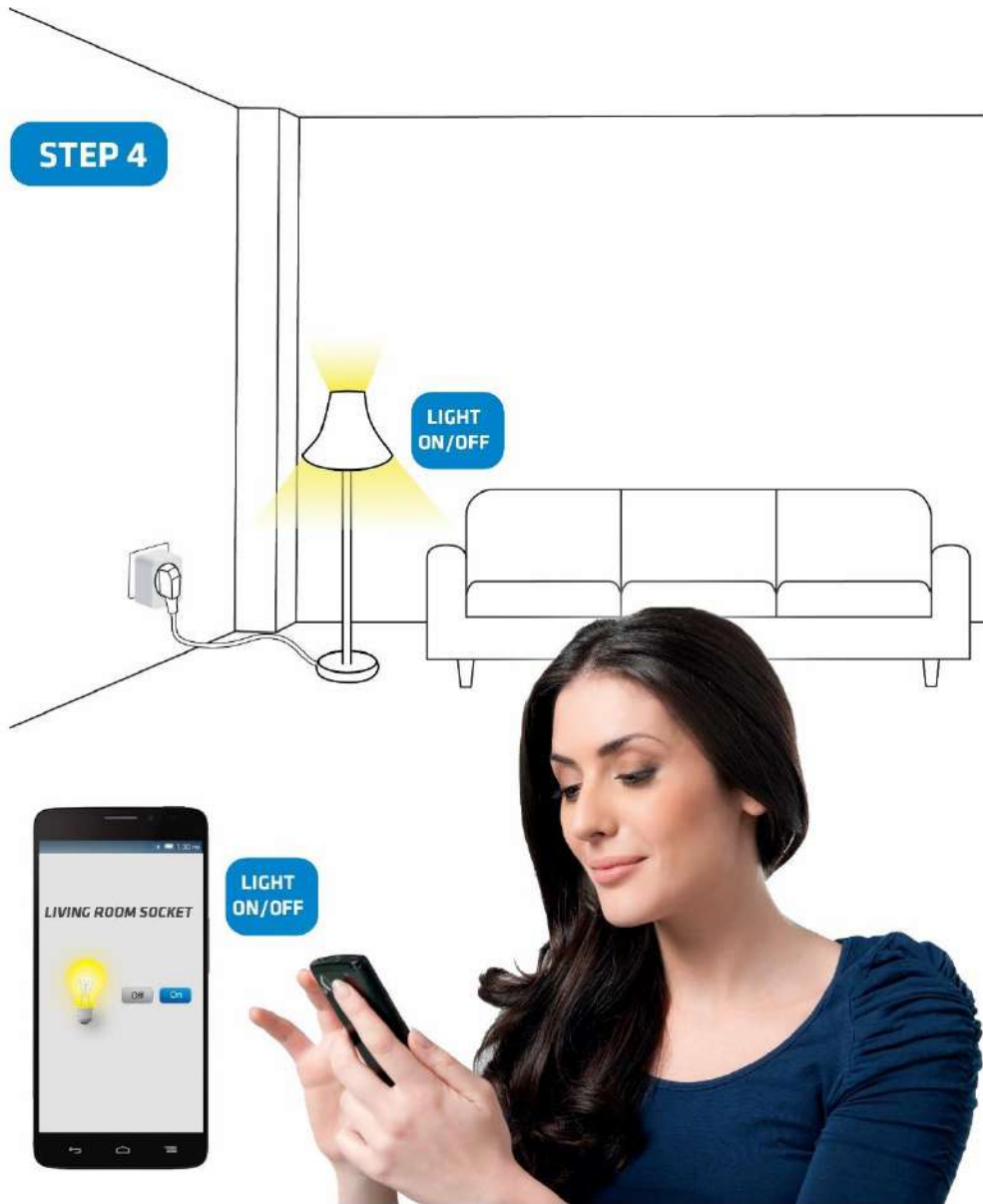

7. Device Information and Support

Did you know that Qubino offers Z-Wave devices with 100% quality control guaranteed throughout the production process? Every single unit is tested and examined before being approved for sale – a truly unique pledge in the industry.

Why is this important?

Every device has a dedicated serial number and part number, which is assigned to the device only after it goes through a strict testing procedure.

By scanning the QR code on the side of your Qubino, its device title, serial number, and part number are automatically copied to your mobile phone. You can also use the code for direct access to the device page for more information. If you still don't find what you're looking for, click on the link to Qubino technical support team. They will be able to automatically read the serial and part number from your device and quickly review the production log file containing the production date as well as any relevant device parameters and information. This process allows our team to immediately identify and address issues, giving you the best support possible.



Based on customer and business partner feedback, we're proud to boast Qubino's support team as the best and fastest on the market. If you don't find the answers to your questions in this document, please contact our support team by scanning the QR code on your device or through our website: <http://qubino.com/support/#email>. We will try to help you as soon as possible.

8. Electrical Diagram 230VAC

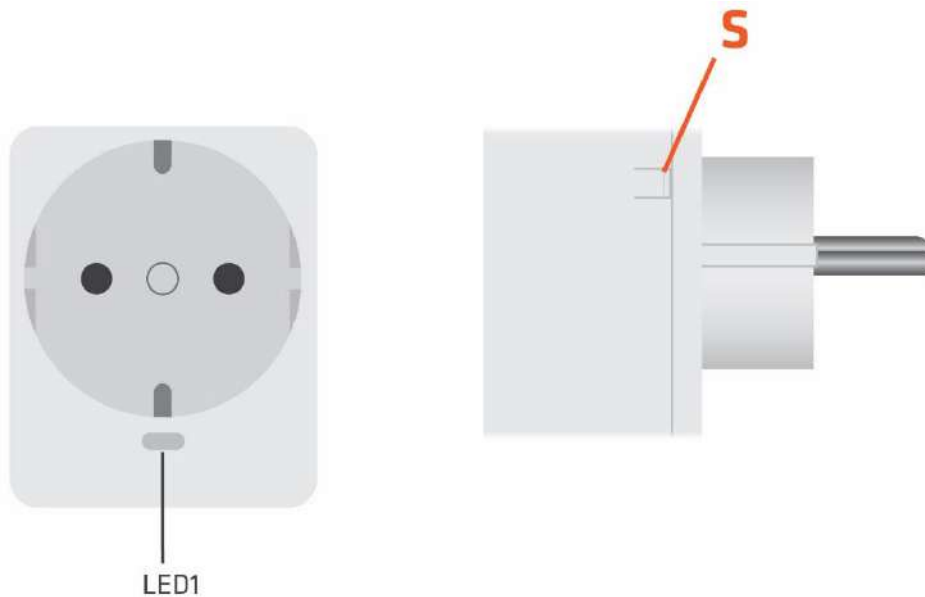

Notes for diagram:

S	Service button (used to add or remove the Smart Plug 16A from the Z-Wave network and for turning the internal relay ON/OFF)
LED1	<p>When the Smart Plug 16A is excluded:</p> <p>When the relay is turned OFF:</p> <ul style="list-style-type: none"> • blue LED is blinking (1 sec ON, 1 sec OFF) <p>When the relay is turned ON:</p> <ul style="list-style-type: none"> • blue LED is ON • red LED is blinking (0.3 sec ON, 0.3 sec OFF) when the current exceeds 14,4A • red LED is ON after the overload occurred <p>When the Smart Plug 16A is included:</p> <p>When the relay is turned OFF:</p> <ul style="list-style-type: none"> • LED is OFF <p>When the relay is turned ON:</p> <ul style="list-style-type: none"> • blue LED is ON • red LED is blinking (0.3 sec ON, 0.3 sec OFF) when the current exceeds 14,4A • red LED is ON after the overload occurred

MEASUREMENTS:

V	Voltage
A	Current
W	Power – Active
kWh	Energy – Active power accumulated

Overcurrent protection

When load is for 5 sec over 16.1A, relay is automatically turned off and “Overcurrent detected” Notification is sent.

To reactivate the device, it has to be pulled out of the power socket and put in again.

Overcurrent warning

When load is near overcurrent state (over 14.4 A), Unsolicited Meter Report is sent and the red LED starts blinking. When the current returns below 14.4 A, the blue LED starts blinking automatically.

9. Adding the device to a Z-Wave network (Inclusion)

AUTOMATICALLY ADDING THE DEVICE TO A Z-WAVE NETWORK (AUTO INCLUSION)

1. Enable add/remove mode on your Z-Wave gateway (hub)
2. Connect the device to the power supply
3. Auto-inclusion will be initiated within 5 seconds of connection to the power supply and the device will automatically enrol in your network

MANUALLY ADDING THE DEVICE TO A Z-WAVE NETWORK (MANUAL INCLUSION)

1. Enable add/remove mode on your Z-Wave gateway (hub)
2. Connect the device to the power supply
3. Press the Service button S 3 times within 3 seconds
4. A new multi-channel device will appear on your dashboard

10. Removing the device from a Z-Wave network (Exclusion)

REMOVAL FROM A ZWAVE NETWORK (Z-WAVE EXCLUSION)

1. Connect the device to the power supply
2. Make sure the device is within direct range of your Z-Wave gateway (hub) or use a hand-held Z-Wave remote to perform exclusion
3. Enable add/remove mode on your Z-Wave gateway (hub)
4. Press the Service button S 3 times within 3 second
5. The device will be removed from your network but any custom configuration parameters will not be erased

FACTORY RESET

- The reset is only possible first minute after the power on
- Press service button S 5 times within 3 seconds – reset the module to factory default and clear NIF+ send device reset locally
- The module is then excluded
- When the S button is pressed 5 times in 3 seconds, the relay should not react!

 By resetting the device, all custom parameters previously set on the device will return to their default values, and the owner ID will be deleted. Use this reset procedure only when the main gateway (hub) is missing or otherwise inoperable.

OPERATION

Internal relay can be switched on/off with:

- Pushing the service button S (press)
- Basic set command
- Switch Binary Set command

11. Associations

Use associations for direct communication between the Smart Plug 16A and other devices within your Z-Wave network without the need of your primary gateway (hub).

Association Groups:

Root device:

- Group 1: Lifeline group (reserved for communication with the main controller), 1 node allowed
- Group 2: This group is assigned to Plug status – On/Off. Allows for sending control command BASIC_SET 0x00/0xFF to associated devices whenever the Plug is turned On or Off, 5 nodes allowed.
- Group 3: This group allows for sending control commands BASIC_SET 0x00/0xFF to associate devices depending on the current load. This association group is configured through the advanced parameters no. 50, 51 and 52; 5 nodes allowed.
- Group 4: This group is equivalent to the association group no. 2. The difference is, that this group sends commands Secure Encapsulated.
- Group 5: This group is equivalent to the association group no. 3. The difference is, that this group sends commands Secure Encapsulated.

12. Configuration Parameters

Parameter no. 10 - Activate / deactivate ALL ON / ALL OFF Functionality

Smart Plug 16A device responds to commands ALL ON / ALL OFF that may be sent by the primary or secondary gateway (hub) within the Z-Wave network.

Values (size is 2 byte dec):

- default value 255
- 255 - ALL ON active, ALL OFF active
- 0 - ALL ON not active, ALL OFF not active
- 1 - ALL ON not active, ALL OFF active
- 2 - ALL ON active, ALL OFF not active



Parameter no. 11 - Turn Smart plug 16A Off Automatically with Timer

If Smart plug 16A is ON, you can schedule it to turn OFF automatically after a period of time defined in this parameter. The timer is reset to zero each time the device receives an ON command, either remotely (from the gateway (hub) or associated device) or locally from the switch.

Values (size is 2 byte dec):

- default value 0
- 0 - Auto OFF Disabled
- 1 - 32535 = 1 - 32535 seconds (or milliseconds – see Parameter no. 15) Auto OFF timer enabled for a given amount of seconds (or milliseconds)

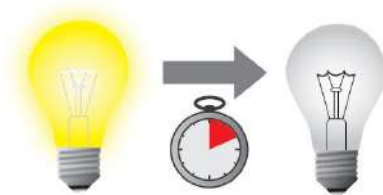

Parameter no. 12 - Turn Smart plug 16A On Automatically with Timer

If Smart plug 16A is OFF, you can schedule it to turn ON automatically after a period of time defined in this parameter. The timer is reset to zero each time the device receives an OFF command, either remotely (from the gateway (hub) or associated device) or locally from the switch.

Values (size is 2 byte dec):

- default value 0
- 0 - Auto ON Disabled
- 1 - 32535 = 1 - 32535 seconds (or milliseconds – see Parameter no. 15) Auto ON timer enabled- for a given amount of seconds (or milliseconds).

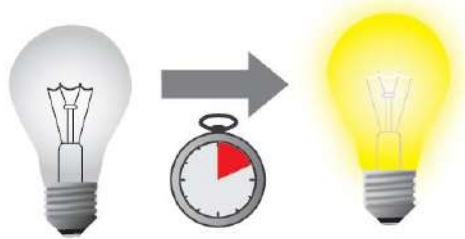
**Parameter no. 15 - Set Timer Units to Seconds or Milliseconds**

Choose if you want to set the timer in seconds or milliseconds in parameters 11 and 12.

Values (size is 1 byte dec):

- default value 0
- 0 – timer set in seconds
- 1 – timer set in milliseconds

Please note that the value for this parameter applies to settings for Smart plug 16A in all of the above parameters (timer on / timer off).



Parameter no. 30 - Restore on/off status for Smart plug 16A after power failure

This parameter determines if on/off status is saved and restored for the Smart plug 16A after power failure.

Values (size is 1 byte dec):

- default value 0
- 0 - Device saves last on/off status and restores it after a power failure.
- 1 - Device does not save on/off status and does not restore it after a power failure, it remains off.

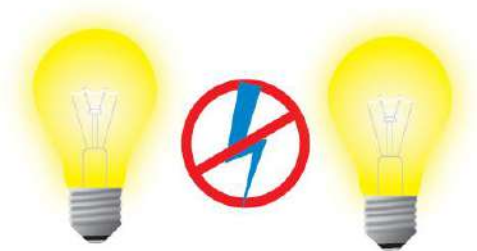
**Parameter no. 40 – Watt Power Consumption Reporting Threshold for Smart plug 16A**

Choose by how much power consumption needs to increase or decrease to be reported. Values correspond to percentages so if 20 is set (by default), the device will report any power consumption changes of 20% or more compared to the last reading.

Values (size is 1 byte dec):

- default value 20
- 0 - Power consumption reporting disabled
- 1 - 100 = 1% - 100% Power consumption reporting enabled. New value is reported only when Wattage in real time changes by more than the percentage value set in this parameter compared to the previous Wattage reading, starting at 1% (the lowest value possible).

NOTE: Power consumption needs to increase or decrease by at least 1 Watt to be reported, REGARDLESS of percentage set in this parameter.

NOTE: When reporting Watts, module will automatically report also [V] (Voltage) and [A] (Amperes)

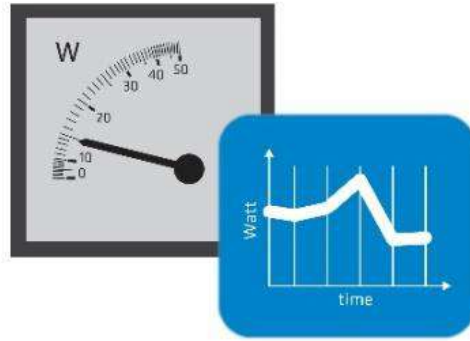

Parameter no. 42 – Watt Power Consumption Reporting Time Threshold for Smart plug 16A Load

Set value refers to the time interval with which power consumption in Watts is reported (0 – 32535 seconds). If 300 is entered (by default), energy consumption reports will be sent to the gateway (hub) every 300 seconds (or 5 minutes).

Values (size is 2 byte dec):

- default value 0
- 0 - Power consumption reporting disabled
- 30 - 32535 = 30 - 32535 seconds. Power consumption reporting enabled. Report is sent according to time interval (value) set here.

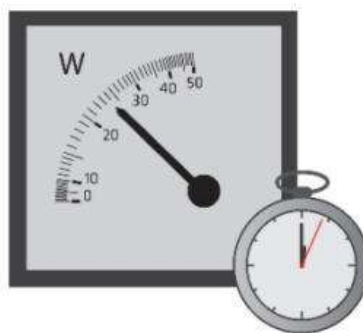

The device is reporting the following values (if there was a change): W, V and A

Parameter no. 50 – Down value

Lower power threshold used in parameter no. 52.

Values (size is 2 byte dec):

- default value 30 = 30 W
- 0 – 4000 = 0W – 4000 W

Down value cannot be higher than a value specified in parameter no. 51

NOTE:

if parameter no. 50 value is 100W

if measured power is lower than 100W, the association is send

association is send again if measured power will rise above 105W

Power threshold step is 1W

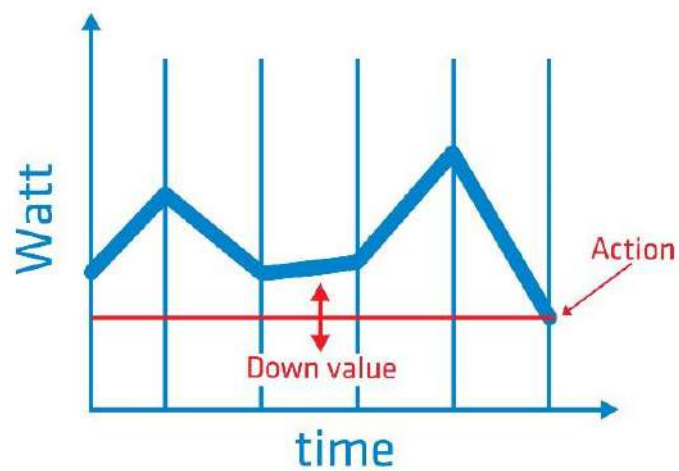

Parameter no. 51 – Up value

Upper power threshold used in parameter no. 52

Values (size is 2 byte dec):

- default value 50 = 50 W
- 0 – 4000 = 0 W – 400 W

Up value cannot be lower than a value specified in parameter no. 50.

NOTE:

If parameter no. 51 value is 200W

If measured power is higher than 200W the association is send

Association is send again if measured power will fall below 190W

Power threshold step is 1W

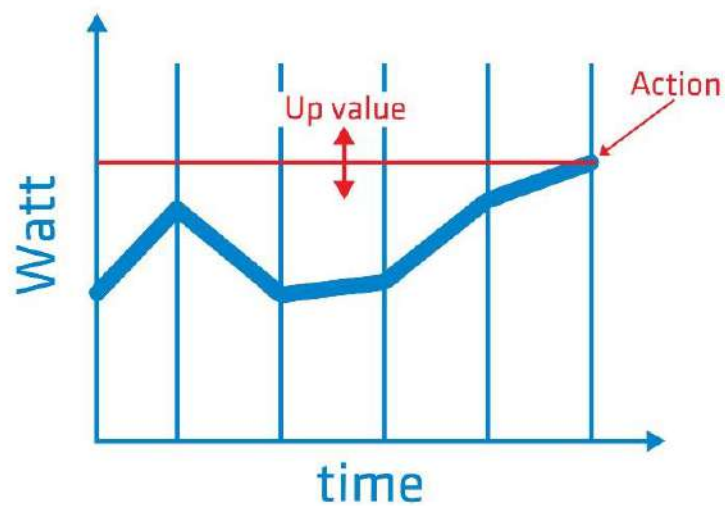

Parameter no. 52 - Action in case of exceeding defined power values (parameters 50 and 51)

Parameter defines the way 3rd association group devices are controlled, depending on the current power load

Values (size is 1 byte dec):

- default value 6
- 0 – function inactive
- 1 – turn the associated devices on, once the power drops below Down value (parameter no. 50)
- 2 – turn the associated devices off, once the power drops below Down value (parameter no. 50)
- 3 – turn the associated devices on, once the power rises above Up value (parameter no. 51)
- 4 – turn the associated devices off, once the power rises above Up value (parameter no. 51)
- 5 – 1 and 4 combined. Turn the associated devices on, once the power drops below Down value (parameter no. 50). Turn the associated devices off, once the power rises above Up value (parameter no. 51).
- 6 – 2 and 3 combined. Turn the associated devices off, once the power drops below Down value (parameter 50). Turn the associated devices on, once the power rises above Up value (parameter no. 51).



Parameter no. 70 - Overload safety switch

The function allows for turning off the controlled device in case of exceeding the defined power for more than 3.1s. Controlled device can be turned back on by S-button or sending a control frame. By default this function is inactive.

Values (size is 2 byte dec):

- default value 0
- 1 – 4000 = 1 W – 4000W
- 0 = function not active

NOTE: This functionality is not an overload safety protection, please check installation note for details.

In case of overload the following message will be send towards the controller:

- COMMAND_CLASS_NOTIFICATION_V5
- The Alarm V1 type field set to 0x08
- Notification Type 0x08 and 0x09 (Load error)

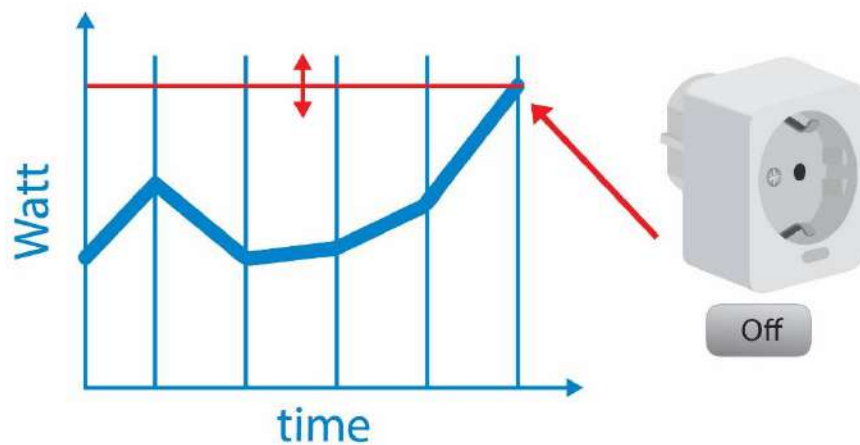

Parameter no. 249 - Enable/Disable Reporting on Set command

Using this parameter it is possible to enable/disable reporting after the set command (i.e. Basic set).

Values (size is 1 byte dec):

- default value 1
- 0 - disable reporting
- 1 - enable reporting

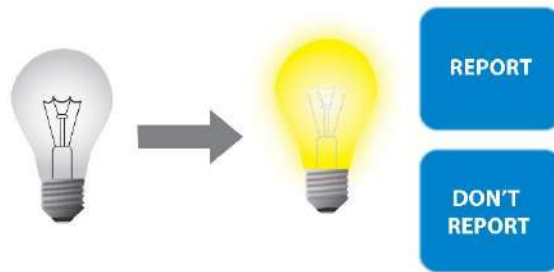

13. Technical Specifications

Power supply	230 VAC \pm 10% / 50 Hz
Power load	16A resistive max.
Overload protection	> 16A
Power consumption	< 1W
Housing dimensions	43 x 52 x 75 mm
Housing colour	white
Weight (ex. packaging)	~ 80g
Z-Wave operation range	up to 30 m indoors (98 ft)
Operating temperature	0 ~ +40°C (32 ~ 104°F); <80% RH non condensing
Storage operation	-20 ~ +70°C (-4 ~ 158°F); <80% RH non condensing
Plug & Socket type	Plug Type F, Socket compatible with type C and F
Switching	Relay

14. Z-Wave Command Classes

Z-Wave Device Class:

GENERIC_TYPE_SWITCH_BINARY
 SPECIFIC_TYPE_POWER_SWITCH_BINARY

Z-Wave Supported Command Classes:

COMMAND_CLASS_ZWAVEPLUS_INFO_V2,
 COMMAND_CLASS_VERSION_V2,
 COMMAND_CLASS_DEVICE_RESET_LOCALLY_1,
 COMMAND_CLASS_MANUFACTURER_SPECIFIC_2,
 COMMAND_CLASS_POWERLEVEL_V1,
 COMMAND_CLASS_SECURITY

Securely Supported Command Classes:

COMMAND_CLASS_BASIC_V1,
 COMMAND_CLASS_SWITCH_ALL_V1,
 COMMAND_CLASS_SWITCH_BINARY_V1,
 COMMAND_CLASS_METER_V4,
 COMMAND_CLASS_NOTIFICATION_V5,
 COMMAND_CLASS_ASSOCIATION_V2,
 COMMAND_CLASS_ASSOCIATION_GRP_INFO_V2,
 COMMAND_CLASS_CONFIGURATION_V1,
 COMMAND_CLASS_FIRMWARE_UPDATE_MD_V2,
 COMMAND_CLASS_MARK,
 COMMAND_CLASS_BASIC_V1

This device can be included and operated in any Z-Wave network with other Z-Wave certified devices from any other manufacturers. All constantly powered nodes in the same network will act as repeaters regardless of the vendor in order to increase reliability of the network.

COMMAND_CLASS_METER

- Default values:
 - Rate Type = 1 (Import)
 - Scale = 0 (kWh)

15. Important Disclaimer

Z-Wave wireless communication is not always 100% reliable. This device should not be used in situations in which life and/or valuables are solely dependent on its functioning. If the device is not recognized by your gateway (hub) or shows up incorrectly, you may need to change the device type manually and make sure your gateway (hub) supports multi-channel devices. Contact us for help before returning the device: <http://qubino.com/support/#email>

16. Warning

Do not dispose of electrical appliances as unsorted municipal waste, use separate collection facilities. Contact your local government for information regarding the collection systems available. If electrical appliances are disposed of in landfills or dumps, hazardous substances can leak into the groundwater and get into the food chain, damaging your health and well-being. When replacing old appliances with new ones, the retailer is legally obligated to take back your old appliance for disposal free of charge.

17. Regulations

Legal Notice

This user manual is subject to change and improvement without notice. GOAP d.o.o. Nova Gorica reserves all rights to revise and update all documentation without any obligation to notify any individual or entity.

Declaration of Conformity

Qubino Smart Plug 16A device is in compliance with the essential requirements and other relevant provisions of the Low voltage (LVD) Directive (2014/35/EU), Electromagnetic Compatibility (EMC) Directive (2014/30/EU), Radio Equipment Directive (2014/53/EU), Directive RoHS 2 (2011/65/EU) and Directive ErP (2009/125/EC).

WEEE

According to the WEEE (Waste electrical and electronic equipment) Directive, do not dispose of this product as household waste or commercial waste. Waste electrical and electronic equipment should be appropriately collected and recycled as required by practices established for your country. For information on recycling of this product, please contact your local authorities, your household waste disposal service or the shop where you purchased the product.



NOTE: User manual is valid for device with SW version S1 (SW version is part of P/N)!

Example:P/N: ZMNHYDxHxS1Px

Goap d.o.o. Nova Gorica

Ulica Klementa Juga 007, 5250 Solkan, Slovenia

E-mail: info@qubino.com

Tel: +386 5 335 95 00

Web: www.qubino.com

Date: 14.3.2018; V 2.2

[DON'T MISS OTHER INVENTIONS FROM QUBINO– CLICK HERE AND CHECK OUT QUBINO'S COMPLETE PORTFOLIO](#)